



FY300 Series

301-302-303

INTELLIGENT VALVE POSITIONER



- Available for the communication protocols: 4 to 20 mA, HART®, FOUNDATION™ fieldbus and PROFIBUS PA
- Automatic Setup
- Single Action or Double Action
- Non-contact position measurement
- Valve position reading from a magnetic Hall Effect sensor
- More usual Characteristic Curves and outlined by user
- Diagnosis for control valves maintenance
- Position sensor available for remote mounting
- Applications in severe vibration and high temperatures
- Easy to be mounted in most of the control valves
- Universal and customized mounting brackets for various control valves manufacturers
- Local adjustment without need to open the housing
- For linear and rotary applications of single or double action
- Display rotation for easy reading in any position
- Supports DD and EDDL for Profibus, suitable for FDT/DTM applications and for use with manual configurator
- Built-in transient suppression
- Hazardous Area Certification, including use in saline atmospheres



smar

The valves control positioners FY300 Series are available in 4 to 20 mA and for systems with HART®, FOUNDATION™ fieldbus and PROFIBUS PA protocol.

FY300 Series positioner provides an output pressure to the control valve actuator, positioning it according to the input received from the output of a controller.

Digital technology used in **FY300 Series** provides an easy interface between the field and the control room, reducing considerably the cost of installation, operation and maintenance.

- Suitable for most brands and models valves;
- A wide variety of customized mounting brackets are available;
- Linear stroke from 3 mm up to 100 mm (for bigger strokes, please consult our ACP 300 Series catalog and BFY-CL mounting brackets);
- Rotary movement from 30° to 120°;
- Configurable either locally or remotely using HART® 4 to 20 mA, FOUNDATION™ fieldbus and PROFIBUS PA protocols;
- Friendly-user rotative display;
- Easy installation, quick commissioning and setup;
- On line continuous diagnostics to reduce troubleshooting time, and unnecessary maintenance;
- Built-in transient protection;
- Histogram and step response combined with asset management applications;
- Trend and load factor also available for diagnosis;
- Configurable valve characteristic curves most used;
- Customized 16 points characteristic curve;
- User Configurable display;
- Configuration password protection;
- Multidrop operation mode;
- Non-contact position sensor;
- Remote mounting available for severe vibration and high temperature applications;
- 20 up to 100 psi air supply pressure;
- Hazardous Area Certification, directives according to EC (European Community);
- Electro-Magnetic Compatibility according to IEC 61000-6-2:2005, IEC 61000-6-4:2006 and IEC 61326:2-3:2006;

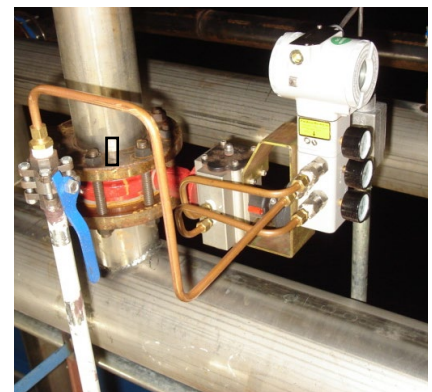

HART® - 4 to 20 mA

- Local adjustment with magnetic tool without need to open the housing;
- HPC401 Configurator for PALM;
- Configuration interface with the CONF401 application on desktop or laptop;
- DEVCOMDROID (Android DDL Interpreter) software, used with HART interfaces, such as the HI331 (Bluetooth Interface) to configure FY301.
- Remote Parameterization and automatic setup;
- FDT/DTM (Field Device Tool / Device Type Manager) capability and connectivity; Connectivity with many Asset Management Applications, including Smar AssetView (consult Smar for other applications);
- Supports DTM;
- Multidrop operation mode.



FOUNDATION fieldbus™

- Fieldbus communication from a PC or via local switch;
- Local configuration with magnetic tool, without needing to open the housing;
- Current consumption of 12 mA;
- Dynamic block instantiation;
- Registered in Foundation Fieldbus™ and approved by ITK;
- 14 function blocks.

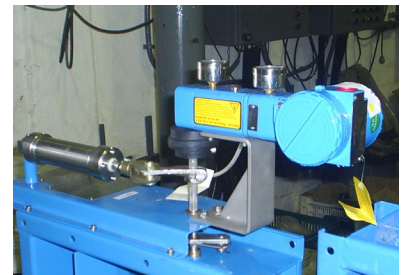

PROFIBUS PA

- Basic configuration can be done using a magnetic tool, without need to open the housing;
- Full Configurable via remote configurator (Smar ProfibusView or Siemens Simatic PDM);
- Functional blocks for analog output and valve diagnostics;
- Current consumption of 12 mA;
- Supports DTM and EDDL.

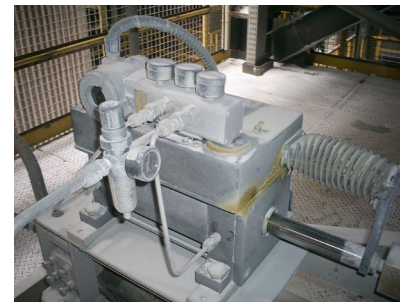

Product Highlight



Universal mounting brackets
(Linear or Rotary).



Positioner with gauge
for pressure monitoring



Rotary magnet for 30 to 120° movement and
Linear magnet for 3 to 100 mm stroke.



The Remote Sensor Position is a recommended accessory for high temperatures applications (up to 105 °C), for excessive vibration or even difficult local access. It avoids equipment excessive wear and, consequently, increases the equipment lifetime.

The remote sensor cable is shielded and therefore provides excellent protection against electromagnetic interference.

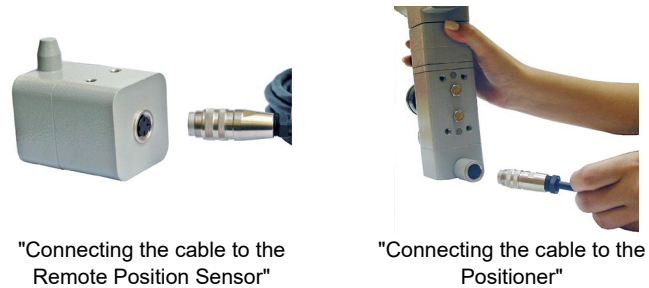

"Connecting the cable to the Remote Position Sensor"

"Connecting the cable to the Positioner"

Remote position sensor

Services and Support

SMAR offers customers first-class technical support and services with a highly specialized, experienced team. We guarantee the maintenance of your system by supplying quality spare parts and services rapidly, in all stages of the project and plant maintenance.

Online Support

Information about certifications, manuals, catalogues, and applications are available at www.smar.com

Functional Description

The FY300 digital positioner uses the most advanced microprocessor to perform an accurate and quick valve positioning. It is a controller which receives a setpoint from the process main controller and move the valve exactly to the ideal position for better process performance.

The FY300 senses the actual stem valve position and it takes the corrective action according to a fully user configurable strategy. The "non-contact" position sensor (Hall effect based) prevents the inadequacy mechanical levers.

The signal from the controller is processed at the main digital circuit board. The analog board gets the information from the main circuit board and generates a low power voltage signal to a piezo electric disc in the pressure transducer. It results in a inflection in such disc, moving it nearer or further away from a nozzle in the pressure transducer. This inflection provides a (pilot) pressure variation proportional to the loop controller.

The diaphragm block amplifies the force related to the pilot pressure and pushes down the spool valve, allowing the supply pressure into the valve actuator. On the other hand, the spool valve movement may relieve the pressure from the valve actuator to the atmosphere.

The valve stem will move in response to the spool valve movement up to the correct position. The actual valve position is read by the magnet sensor (Hall effect) and feedback to the main circuit board. With the position information (readback signal), the microprocessor will drive a signal to the analog circuit, correcting the valve position.

FY300 schematic cut view

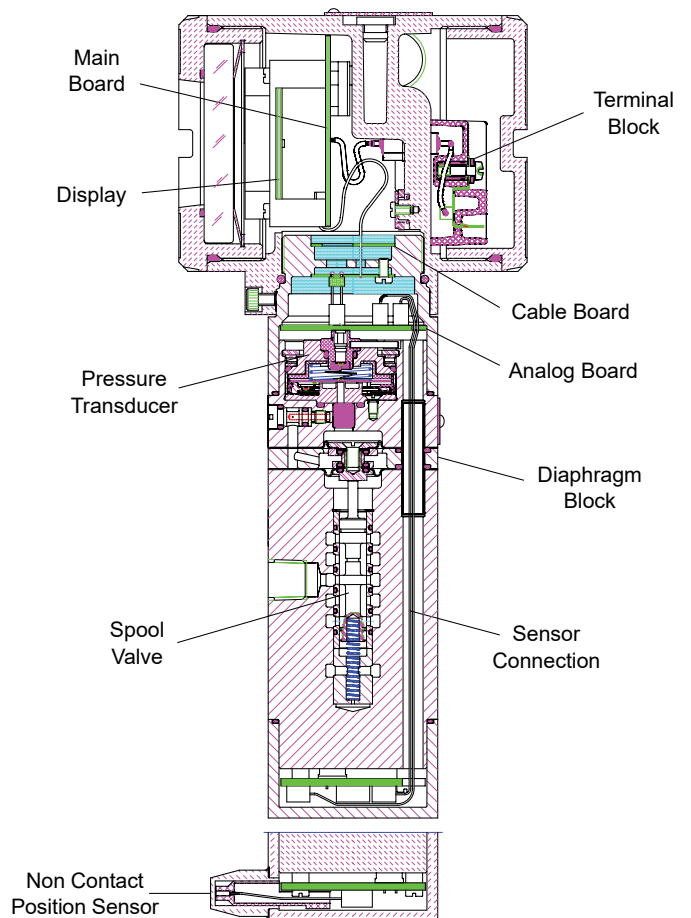

The microprocessor uses the control algorithm to eliminate the valve position error. The controller parameters are easily tuned automatically through a single command given locally via magnetic tool or a hand held programmer. It is also possible to configure the **FY300 Series** with applications based on the FDT/DTM technology.

Smar **FY300 Series** is designed for easily assembling in the field or inside the workshop. There are universal mounting brackets (in carbon and stainless steel) for both rotary and linear actuators.

Additionally, a wide variety of customized mounting brackets are available.

Check the availability and select the mounting bracket that meets the needs of your process on the product page on the Smar website: <https://www.smar.com/brasil/produto/fy300series-posicionador-inteligente-de-válvulas>

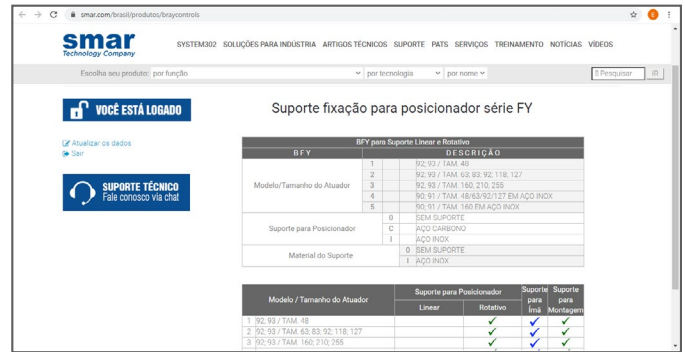

Smar's internet page for customized mounting brackets selection

Positioner Models

Linear

Configurable via software, from 3 mm up to 100 mm stroke, selected from the linear magnet and mounting bracket choices according to the required stroke.

Rotary

Configurable via software (local or remotely) from 30° to 120° with rotary magnet and proper mounting bracket.

Local Non-contact Position Sensor

Regular positioner with integrated position sensor.

Remote Non-contact Position Sensor

Most appropriate on applications involving high temperature and vibration. Also suitable for places with difficult access. Available from 5 m to 20 m cable length.

Pressure Sensors

In addition to the regular information on the valve and positioner status, the pressure sensors are also useful for advanced diagnosis.

Double and Action Single

With the same positioner, it is possible to control the double action valves position or with a return spring.



FY300 Series is available in **HART®**, **FOUNDATION™ Fieldbus** e **PROFIBUS PA** technology. These instruments can be configured with Smar software and other manufacturer configuration tools. Local adjustment is available in all **FY300 Series**. It is possible to configure the valve type and characteristics, manual or automatic setup, local or remote setpoint, tight-shut-off and other control functions using the magnetic tool.

Smar has developed the AssetView, a management application software, which is an user-friendly Web Tool, accessed from anywhere and at anytime using an internet browser. The AssetView has incorporated the advantages of FDT technology. It is designed for management and diagnostics of field devices, to ensure reactive, preventive, predictive and proactive maintenance.

HART® FY301

FY301 with HART® protocol can be configured by:

- DEVCOMDROID Smar software, used with HI331 (Bluetooth Interface);
- Smar CONF401;
- Smar DDCON 100;
- Smar HPC401;
- Other manufacturers' configuration tools based on DD (Device Description), AMST™, Simatic PDM, and FDT/DTM, such as, FieldCare™, PACTware™, HHT275 and HHT375, PRM Device Viewer.

For FY301 management and diagnostics, AssetView ensures continuous information monitoring.

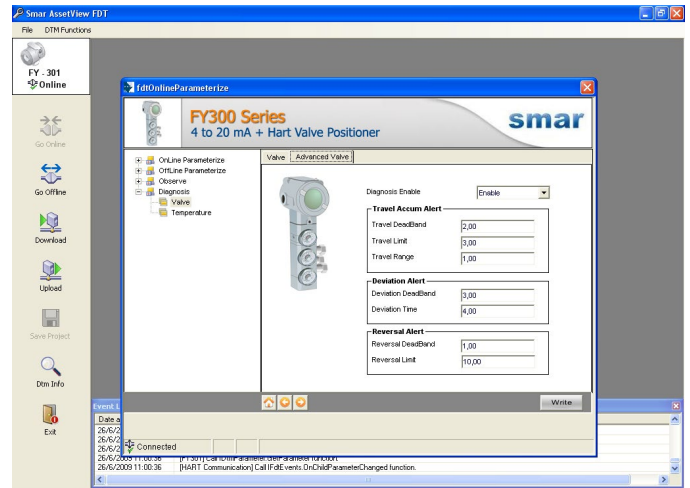

FOUNDATION™ Fieldbus FY302

FY302 utilize the Foundation™ Fieldbus H1 protocol, an open technology that allows any H1 enable configuration tool to configure this device.

Smar Syscon (System Configuration Tool) is a software tool used to configure, maintain and operate the field devices. Syscon offers efficient and friendly interaction with the user, using Windows.

Configuration tools such as AMST™, FieldCare™ and HHT375 can configure FY302 devices. DD (Device Description) and CF (Capability File) files can be downloaded at either the Smar or Fieldbus Foundation™ website.

FY302 supports complex strategies configurations due to the high capacity and variety of dynamic instantiable function blocks.

Fourteen different types of function blocks are supported, and up to twenty function blocks can be running simultaneously. Maintenance procedures with AssetView diagnostics and status information from Foundation™ fieldbus result in a safer plant with higher availability.

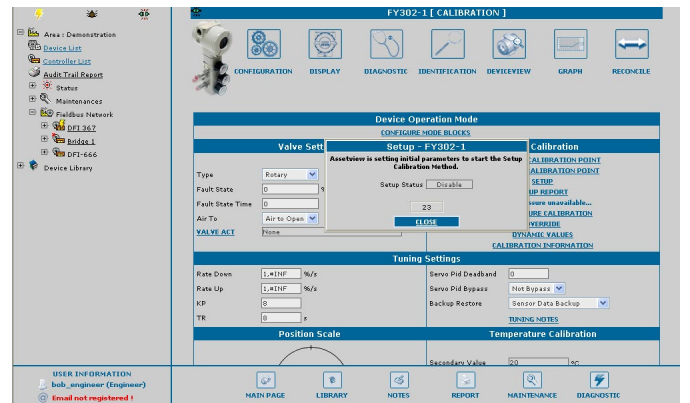

PROFIBUS PA FY303

These instruments can be configured with Smar software and other manufacturer configuration tools.

FY303 (PROFIBUS PA protocol) can be configured using Smar ProfibusView or Simatic PDM and by the FDT (Field Device Tool) and DTM (Device Type Manager) concept tools, such as FieldCare™ and PACTware™. It can also be integrated by any PROFIBUS System using the GSD file.

PROFIBUS PA also has quality and diagnostic information, improving plant management and maintenance.

Files EDDL (Electronic Device Description Language) and DTM are available on the Smar home page.



HART® - FY301

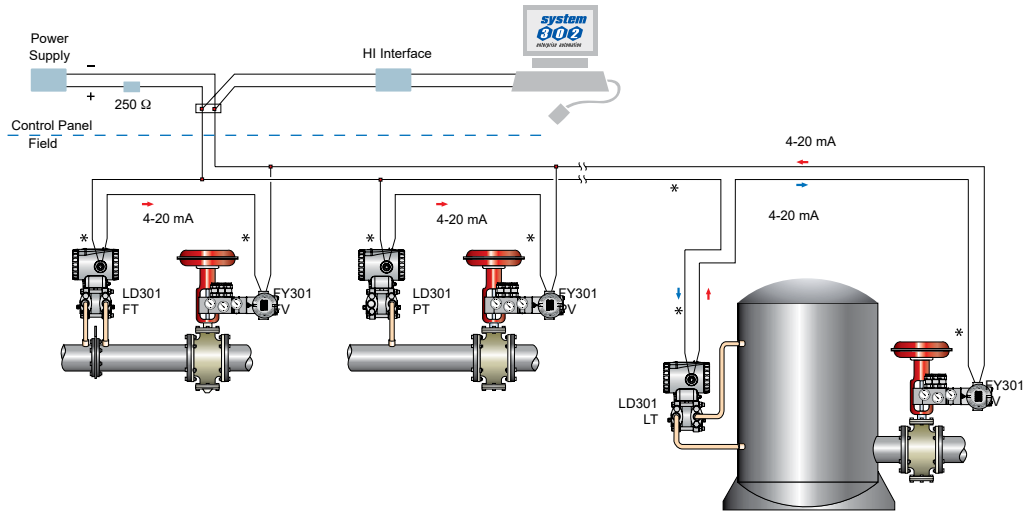

FOUNDATION™ fieldbus - FY302

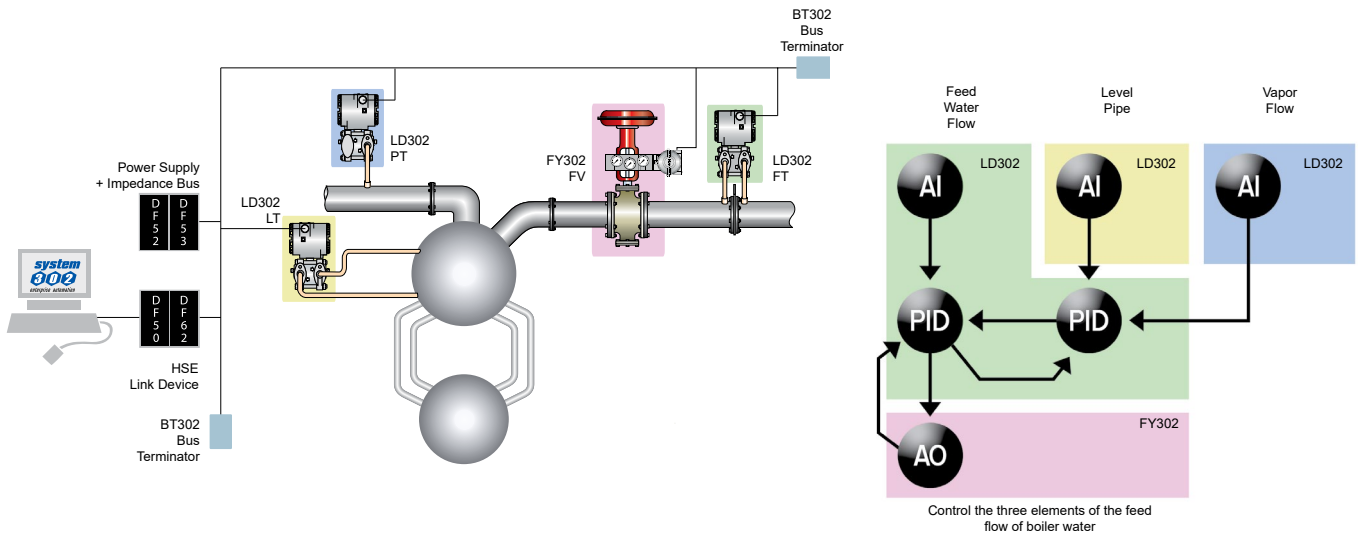

PROFIBUS - FY303

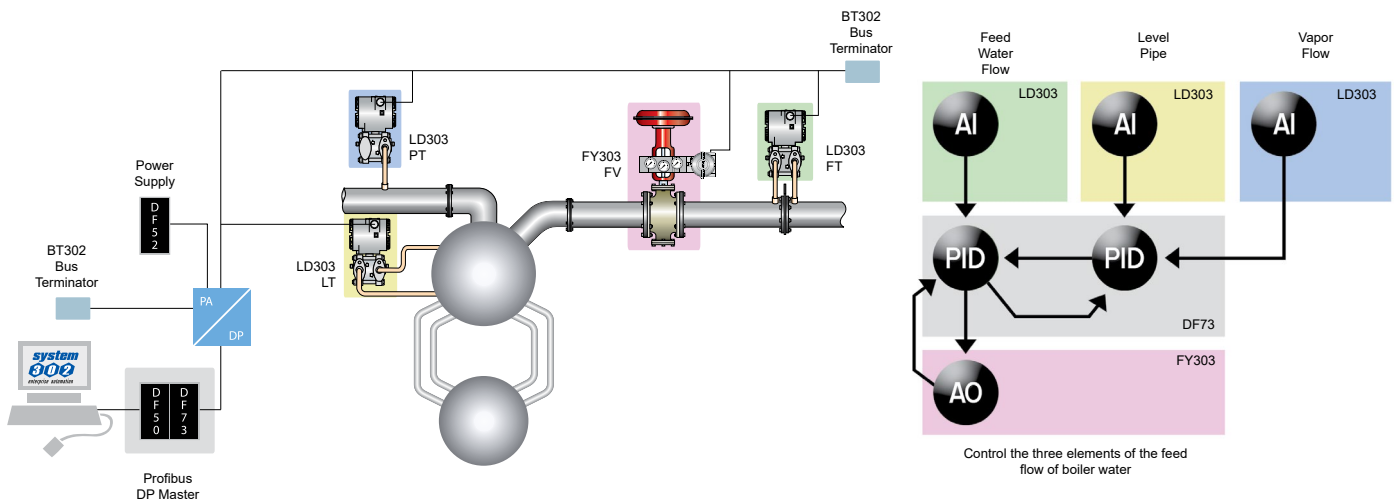

Functional Specifications

Travel	Linear Motion: 3 - 100 mm. Rotary Motion: 30° - 120° Rotation Angle.
Input and Communication Protocol	HART® Two-wire, 4-20 mA controlled according to NAMUR NE43 specification, with super-imposed digital HART® Protocol. FOUNDATION™ fieldbus and PROFIBUS PA Digital only. Fieldbus, according to IEC 61158-2 (H1) 31.25 Kbits/s with bus power.
Power Supply	HART® 4 mA to 20 mA Input via controller. Voltage Drop equivalent to 550 Ω. Input protected against reverse polarity and transient suppressor. FOUNDATION™ fieldbus and PROFIBUS PA Bus powered: 9-32 Vdc. Current consumption quiescent: 12 mA.
Indicator	Rotative LCD, with 4½-numerical digit and 5-character alphanumeric. Function and status icons.
Gage	For pressure monitoring and output supply. 0 to 160 psi scale. Acrylic display, 304 Stainless Steel connections and flexible parts in Brass.
Hazardous Area Certifications	HART®, FOUNDATION™ Fieldbus and PROFIBUS PA INMETRO certification (CEPEL), FM, ATEX and IECEX (Nemko-Presafe and Dekra-Exam) for intrinsically safe and explosion proof, INMETRO (CEPEL) and FM for dust ignition proof. FOUNDATION™ Fieldbus and PROFIBUS PA FISCO Field Device Ex ia IIC T4 Ga FISCO Field Device Ex n1 IIC T4 Gc
European Directive Information	FY300 is in compliance with the related directives. It was designed and manufactured in accordance with good engineering practices using ANSI, ASTM, DIN and JIS standards. Quality Management System audited by BVQI (Bureau Veritas Quality International) for the Management Systems certification. EMC Directive (2014/30/EU) - Electromagnetic Compatibility The EMC test was performed according to standard: IEC61326-1. ATEX Directive (2014/34/EU) - Explosive Atmosphere, Hazardous Location The EC-Type Examination Certificate had been released by DNV GL Presafew (CE2460) and DEKRA GmbH (CE0158), according to European Standards. The certification body for Production Quality Assurance Notification (QAN) and Quality Assessment Report (QAR) is Nemko AS (CE0470).
Flow Characterization	Linear, Equal Percentage, Quick Opening, 16-point freely configurable table.
Temperature Limits	Operation: -40 to 85 °C (-40 to 185 °F). Storage: -40 to 90 °C (-40 to 194 °F). Display: -10 to 75 °C (14 to 167 °F) operation. -40 to 85 °C (-40 to 185 °F) without damage. Remote Sensor Operation: -40 to 105 °C (-40 to 221°F).
Voltage Drop	11 Vdc Max / 20 mA (equivalent to 550 Ω).

Configuration	<p>HART® Through digital communication, using DevComDroid configuration software (Android DDL Interpreter), used with HART interfaces, such as HI331 bluetooth interface. However, the old Palm with HPC301 or CONF401, which are obsolete, are still operable with the latest versions of HART transmitters. The FY300 HART® can also be configured using third-party configuration tools, and can be partially configured through local adjustment using the Smar magnetic tool.</p> <p>FOUNDATION™ fieldbus and PROFIBUS PA Basic configuration can be done through of setting place with magnetic tool only if the equipment has a display. The full configuration is possible only using the configuration softwares.</p>
Humidity Limits	0 to 100% RH (Relative Humidity non-condensable).
Current	<p>HART® 3.8 mA (minimum).</p> <p>FOUNDATION Fieldbus™ and PROFIBUS PA Bus power: 9 - 32 Vdc. Current consumption quiescent: 12 mA.</p>
Position Sensor	Non-contact Hall effect sensor. Available in remote and integral versions.
Pressure Supply	1.4 - 7 bar (20-100 psi). Free of oil, dust and water, as per ANSI/ISA S7.0.01-1996.

Performance Specifications

Resolution	< 0.1% F.S.
Pressure Supply Effect	Negligible.
Repeatability	< 0.1% F.S.
Consumption	0.35 Nm ³ /h (0.20 SCFM) at 1.4 bar (20 psi) supply. 1.10 Nm ³ /h (0.65 SCFM) at 5.6 bar (80 psi) supply.
Ambient Temperature Effect	0.8%/20 °C of span.
Output Capacity	13.6 Nm ³ /h (8 SCFM) at 5.6 bar (80 psi) supply.
Vibration Effect	± 0.3 % /g of span during the following conditions: 5 -15 Hz at 4 mm constant displacement. 15 -150 Hz at 2g. 150 - 2000 Hz at 1g. Comply with SAMA PMC 31.1 - 1980, Sec. 5.3, Condition 3, Steady State.
Electro-Magnetic Interference Effect	According to the IEC61326-1 standard.

Physical Specifications

Electrical Connection See Note (*)	<p>½ - 14 NPT M20 X 1.5 PG 13.5 DIN</p>	<p>¾ - 14 NPT (with 316 SST adapter for ½ - 14 NPT). ¾ - 14 BSP (with 316 SST adapter for ½ - 14 NPT). ½ - 14 BSP (with 316 SST adapter for ½ - 14 NPT).</p>
Pneumatic Connections	<p>Supply and output: ¼ -18 NPT. Gage: - 1/8 - 27 NPT.</p>	
Material of Construction	<p>Injected low copper aluminum with polyester painting or 316 Stainless Steel housing, with Buna N O-Rings on cover (NEMA 4X, IPW 66). Identification Plate: 316 SST.</p>	
Mounting	<p>Universal brackets for rotary motion and linear strokes (See BFY ordering code). Optional customized brackets for most of the market valves and final elements (Consult www.smar.com for availability and brackets selection). Additional “L” shape bracket, in carbon and Stainless Steel for 2” pipe mounting (remote sensor version).</p>	
Approximate Weights	<p>Without display and mounting bracket: 5.8 kg (316 SST). 2.7 kg (aluminum).</p> <p>Remote sensor: 0.58 kg in aluminum 1.5 kg in SST</p> <p>Cable and connectors of remote sensor 0.045 kg/m of cable 0.05 kg for each connector</p>	
Pressure Sensors	<p>For air supply, output 1 and output 2 measurements. (Optional Consult Smar for applications in classified areas).</p>	

HART® is a trademark of HART® Communication Foundation.
FOUNDATION™ Fieldbus
PROFIBUS PA

(*) Consult Smar for applications in classified areas.

MODEL	SMART VALVE POSITIONER										
FY301 FY302 FY303	HART® & 4 to 20 mA FOUNDATION™ fieldbus PROFIBUS PA										
CODE Local Indicator											
0	Without Indicator										
1	With Digital Indicator										
CODE Mounting Bracket (8)											
0	Without Bracket										
1	With Bracket										
CODE Electrical Connections											
0	1/2" - 14 NPT (4)							3 1/2" - 14 NPT X 1/2 BSP (316 SS) - with adapter (3)			
1	1/2" - 14 NPT X 3/4 NPT (316 SS) - with adapter (5)							A M20 X 1.5 (4)			
2	1/2" - 14 NPT X 3/4 BSP (316 SS) - with adapter (3)							B PG 13.5 DIN (3)			
CODE Type of Actuator											
1	Rotary - Single Action							A Linear Stroke Up to 30 mm - Single Action			
2	Rotary - Double Action							B Linear Stroke Up to 30 mm - Double Action			
5	Linear Stroke Up to 50 mm - Single Action							C Without magnet (for linear actuator) - Single Action			
6	Linear Stroke Up to 50 mm - Double Action							D Without magnet (for linear actuator) - Double Action			
7	Linear Stroke Up to 100 mm - Single Action							Z Others Specify			
8	Linear Stroke Up to 100 mm - Double Action										
CODE Indication Gage											
0	Without Gage							9 Whit 2 Gage (Acrylic, Stainless steel and wetted parts in brass) - Output 1 and 2			
6	With 1 Gage (Acrylic, Stainless steel and wetted parts in brass) - Input							A With 3 Gage (Acrylic, Stainless steel and wetted parts in brass)			
7	With 1 Gage (Acrylic, Stainless steel and wetted parts in brass) - Output 1							Z Others Specify			
8	With 2 Gage (Acrylic, Stainless steel and wetted parts in brass) - Input and Output 1										
SPECIAL OPTIONS (Leave it blank for no optional items)											
CODE Housing											
H0	Aluminum (IP/TYP E)							H3 316 Stainless Steel for saline atmosphere (IPW/TYP E X) (2)			
H1	316 Stainless Steel (IP/TYP E)							H4 Copper Free Aluminum (IPW/Type X) (2)			
H2	Aluminum for saline atmosphere (IPW/TYP E X) (2)										
CODE Identification Plate											
I1	FM: XP, IS, NI, DI (USA)							I6 Without certification			
I3	CSA: XP, IS, NI, DI (CANADIAN)							ID NEPSI: EX-IA, EX-D (PROFIBUS PA) - FY302 and FY303			
I4	EXAM: EX-IA, NEMKO: EX-D ATEX (GAS)							IO CEPEL: (INMETRO - DUST)			
I5	CEPEL: EX-D, EX-IA INMETRO (GAS)										
CODE Painting											
P0	Gray Munsell N 6.5 Polyester										
P8	Without Painting										
P9	Blue Safety Epoxy – Electrostatic Painting										
PD	Blue smooth diamond RAL5010 - Epoxy										
CODE TAG Plate											
J0	With TAG										
J1	Blank										
J2	According to user's notes										
CODE Sensor Mounting (1) (6)											
R0	Full Mounting										
R1	Remote sensor - 5 m cable										
R2	Remote sensor - 10 m cable										
R3	Remote sensor - 15 m cable										
R4	Remote sensor - 20 m cable										
R9	Remote Mounting (adapted for Remote Sensor, without cable and remote extension set)										
RZ	Special - See notes										
CODE Special Sensor											
K0	Without special sensor										
K1	With pressure sensors for diagnostic										
K2	With 4-20 mA Position Feedback (open collector) - FY301										
CODE Special											
ZZ	Leave it blank for no optional items										

FY301	-	1	-	1	-	0	8	A	•	H0	/	I6	/	P0	/	J1	/	R0	/	K0	/	*
FY302	-	1	-	1	-	0	8	A	•	H0	/	I6	/	P0	/	J1	/	R0	/	*	/	*
FY303	-	1	-	1	-	0	8	A	•	H0	/	I6	/	P0	/	J1	/	R0	/	*	/	*

← TYPICAL MODEL NUMBER

NOTES:

- (1) Consult Smar for applications in classified areas.
- (2) IPW/TYP E tested for 200 hours according to NBR 8094 / ASTM B 117 standard.
- (3) Options not certified for Hazardous Locations.
- (4) Certification Ex-d for FM, ATEX, IECEx and INMETRO.
- (5) Certification Ex-d for INMETRO.
- (6) When choosing the Remote Sensor version, an additional "L" form support for a 2" tube will be included for fixing the FYRemote. To fix the Remote Sensor to the actuator, it is necessary to specify the BFY according to the ordering code.

MODEL	
BFY	BRACKET (1)
CODE	Positioner Mounting Bracket (2)
0	Without Bracket
1	Universal Rotary
2	Universal Linear (Yoke and Pillar Type)
3	Linear - Yoke Type
4	Linear - Pillar Type
Z	Others - Specify
CODE	Magnet Mounting Bracket
0	Without Bracket
1	Rotary
2	Linear up to 30 mm
3	Linear up to 50 mm
4	Linear up to 100 mm
Z	Others - Specify
CODE	Positioner Mounting Bracket Material
7	Carbon Steel Bracket and Accessories in SST
C	Carbon Steel Bracket
I	Stainless Steel Bracket
N	Not applicable
Z	Others - Specify
CODE	Magnet Bracket Material
C	Carbon Steel Bracket
I	Stainless Steel Bracket
N	Not applicable
Z	Others - Specify
CODE	Optional Items
ZZ	Leave it blank for no optional item

BFY	2	4	-	C	I	/	*	← TYPICAL MODEL NUMBER
------------	----------	----------	----------	----------	----------	----------	----------	------------------------

(1) When choosing the remote sensor version, and additional "L" shape bracket is included, for 2" tube mounting.
 (2) For customized mounting bracket, for different brands and models, please, consult www.smar.com.

VA L V E POSITIONER

All dimensions are in mm (in)

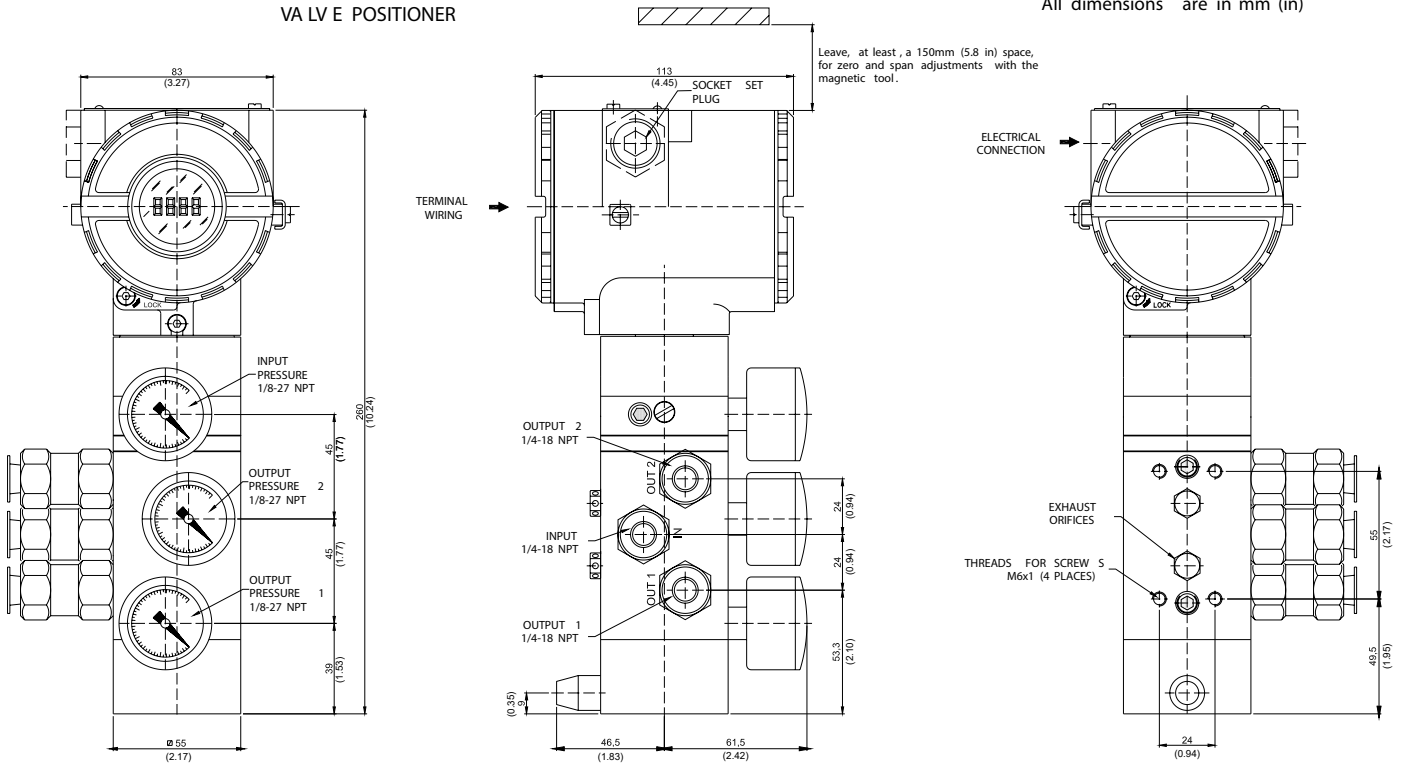

LINEAR MAGNET

ROT AR Y MAGNET

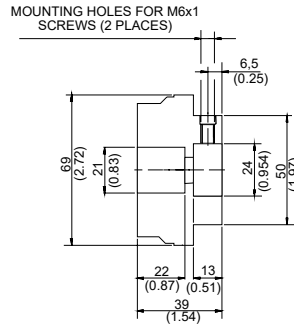
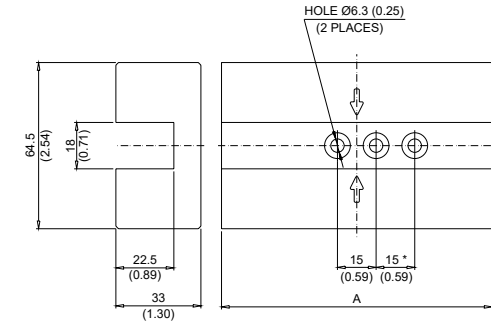

TRAVEL	DIMENSION A
UP TO 30 mm (1.18)	67 mm (2.64)
UP TO 50 mm (1.97)	105 mm (4.13)
UP TO 100 mm (3.94)	181 mm (7.12)

*ONLY FOR 50 AND 100 mm TRAVELS.

Note: Dimensions in mm (in)

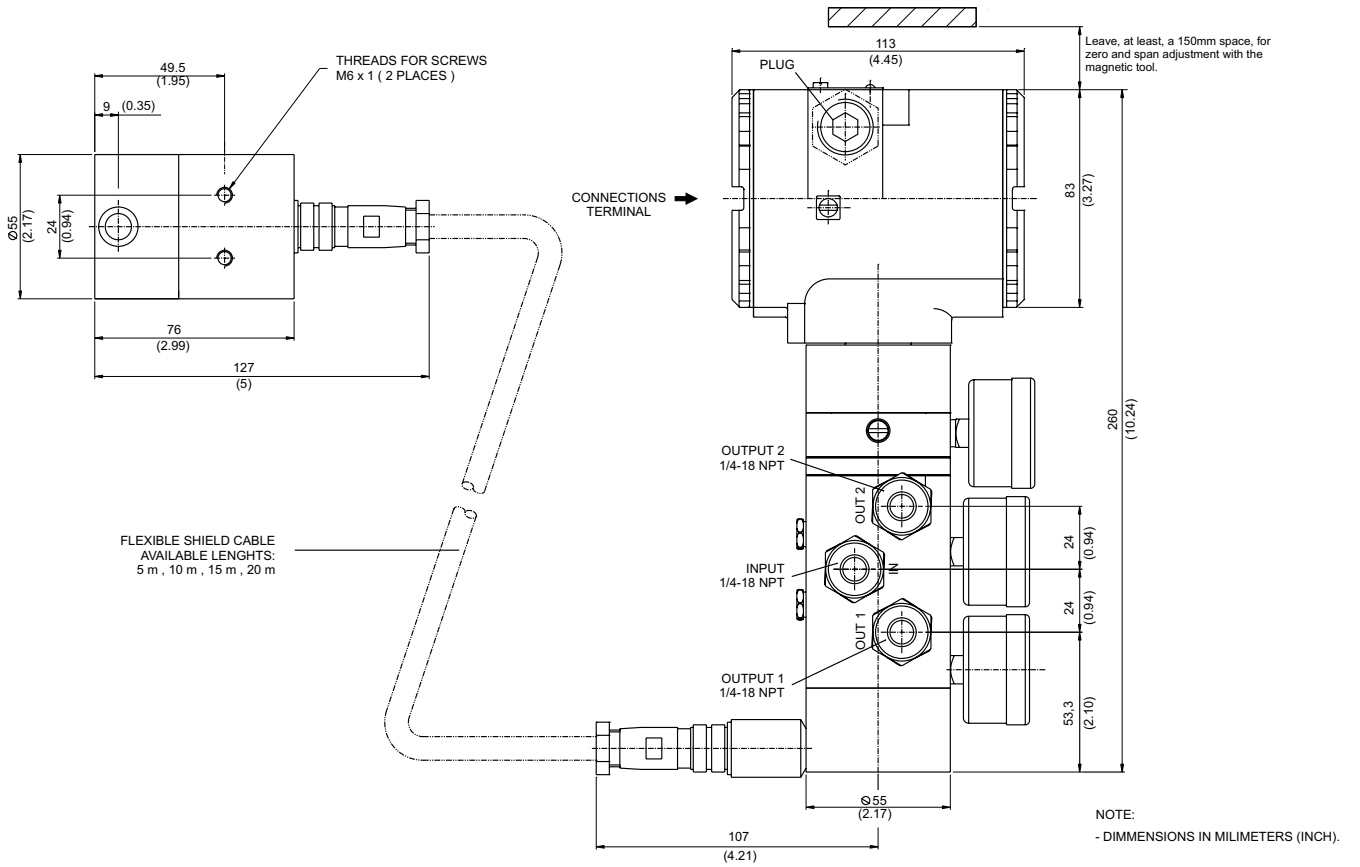

smar
NOVA SMAR S/A
www.smar.com

Specifications and information are subject to change without notice.
Up-to-date address information is available on our website.

web: www.smar.com/contactus.asp

