



TP300 Series

2290 - 301 - 302 - 303

SMART TRANSMITTER FOR POSITION MEASUREMENT

TO MEASURE LINEAR OR ROTARY DISPLACEMENT OR MOVEMENT

- Available for 4 to 20 mA, HART®, FOUNDATION™ fieldbus and PROFIBUS PA communication protocols
- Position measurement without mechanical contact
- Position measurement carried out through a Hall Effect magnetic sensor
- Available for remote mounting position sensor
- Applications in high vibrations, high temperatures and hard-access locations
- Easy to assembly
- Local adjustment without need to open the transmitter housing
- For linear and Rotary applications
- Rotary display facilitates reading in any position
- Supports DD and EDDL formats for FDT/DTM applications
- Protection against reverse polarity
- Explosion-proof and intrinsically safe (ATEX (NEMKO and DEKRA EXAM), FM, CEPEL and CSA)
- Designed to comply with European regulations ATEX 94/9/EC, LVD 2006/95/EC and EMC 2004/108/EC standards



smar

The **TP300** is a member of the renowned family of Smar equipment available in HART® 4 to 20 mA, FOUNDATION™ fieldbus and PROFIBUS PA.

This product line presents the TP290 version, also with digital technology and a 4 - 20 mA output signal.

The **TP300** is a smart transmitter for position measurement, suitable for linear or rotary displacement or movement. Its digital technology and communication provides a friendly interface between the field and the control room, presenting features that considerably reduce installation, operation and maintenance costs.

The **TP300** uses a magnetic coupler without physical contact for position measurement. For this reason it is immune to vibration effects and provides longer operational durability. The magnetic coupler replaces the mechanical connection a significant dead band reduction and preventing inaccurate results from wearing out by use. The **TP300** may be installed in any equipment with linear or rotary motion and a variety of other devices such as skylights, dampers, rollers spacing, crushers, etc.

The **TP300** also offers other advantageous functions in comparison to other position transmitters as:

- Linear movement range from 3 mm through 100 mm: for longer courses, consult our BFY-CL Series catalog;
- Rotary movement range from 0° to 30° until 0° to 120°;
- Local or remote configuration through HART® 4 to 20 mA, FOUNDATION™ fieldbus and PROFIBUS PA protocols;
- Multifunctional, easy to use, local rotary display;
- Easy to install, fast commissioning and adjustment;
- Configuration protection by password;
- Protection against reverse polarity;
- Hall-Effect contactless position sensor that measures the device movement;
- Remote sensor version available with extension cable for applications with difficult access or involving high vibration and high temperature.

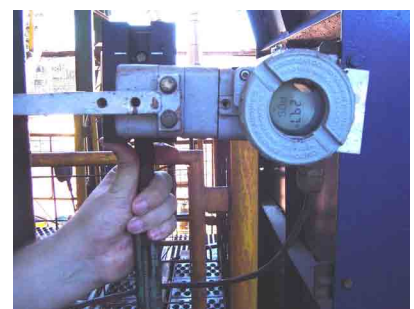

HART® - 4 to 20 mA

- Connectivity through:
 - CONF 401 configuration interface;
 - Palm HPC301 and HPC401 configurator;
 - Remote parameterization;
 - Local adjustment without need to open the equipment housing;
 - FDT/DTM standard applicatives (Field Device Tool/Device Type Manager);
 - Asset Management applicatives (AssetView).
- Supports DTM and EDD;
- Multidrop operation mode.



FOUNDATION™ fieldbus

- Fieldbus communication from PC or via local switch;
- Local configuration with magnetic tool, without need to open the housing or configurator HPC401;
- 12 mA consumption current;
- Dynamic block instantiation;
- 11 functional blocks.



PROFIBUS PA

- Connectivity through:
 - Basic configuration with magnetic tool;
 - Complete configuration carried out with a remote configurator (Ex: Smar ProfibusView).
- Functional blocks for analog output and valve diagnostics;
- 12 mA current consumption;
- Supports DTM and EDDL.



Product Highlights

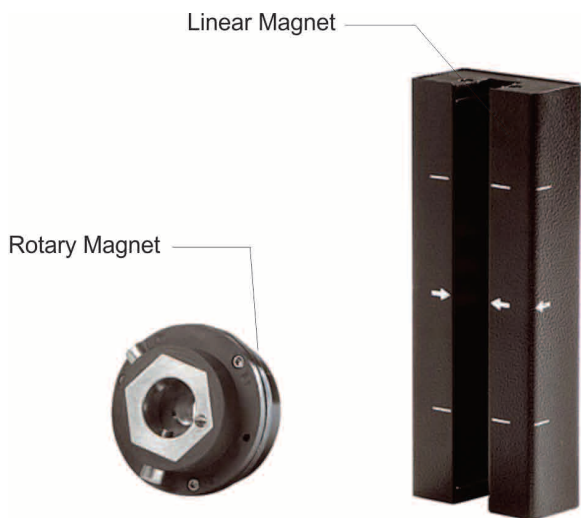

Rotary magnet for 30° to 120° movement and linear magnet for 3 to 100 mm stroke.

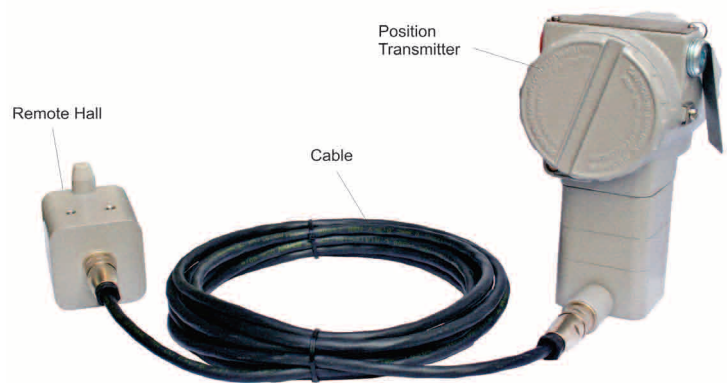

Position transmitter: local contactless Position Sensor, or remote contactless Position Sensor.

The Remote Sensor Position is a recommended accessory for high temperatures applications (up to 105 °C), for excessive vibration or even difficult local access. It avoids equipment excessive wear and, consequently, increases the equipment lifetime.

The cable supplied by Smar is shielded and provides excellent protection against electromagnetic interferences.

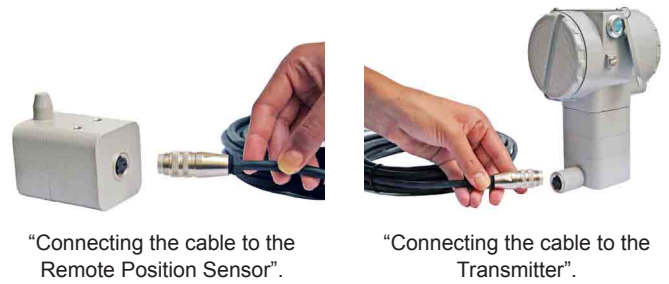

Remote Position Sensor

Services and Support

SMAR offers customers first-class technical support and services with a highly specialized, experienced team. We guarantee the maintenance of your system by supplying quality spare parts and services rapidly, in all stages of the project and plant maintenance.

Online Support

We provide information and technical support via the Internet at <http://www.smar.com/liveperson.asp>, where customers can find detailed information about SMAR products and services. Registered users may submit technical questions and visit the Most Frequent Asked Questions section. Responses are quick, usually in less than 24 hours, via chat, e-mail or telephone (except on weekends and holidays). Our support team is made up of qualified engineers and technicians who provide basic consultation and assistance for initial configurations and engineering.

Functional Description

Hall Effect Position Sensor

The magnet measure according to the motion of the device. The Hall sensor circuit detects the voltage variation and generates a small voltage proportional to the variation of the magnetic field.

The Hall sensor circuit processes the voltage variation and generates a signal to the A/D converter. The converter emits a set of signals the transmitter CPU.

Hart® Modem

Modulates and demodulates the line communication signal. The “1” represents 1200 Hz and the “0” represents 2200 Hz, as specified by the standard. The frequency signal is symmetrical and does not affect the 4-20 mA output DC current level.

Fieldbus Modem

Monitors the activity on line, modulates and demodulates the communication signals; inserts and deletes, limits the beginning and the end and verifies the integrity of the received frame.

CPU, RAM, PROM and EEPROM

The CPU is the intelligent part of the position transmitter, one that is responsible for the management, operation, control and self-diagnostics. The program is stored in the PROM. For temporary storage of data the CPU has an internal RAM. The CPU has a non-volatile internal memory (EEPROM) where configuration data are stored, such as TP301 calibration and configuration.

Display Controller

Receives data from the CPU and controls the LCD display.

Schematic Section of the TP300

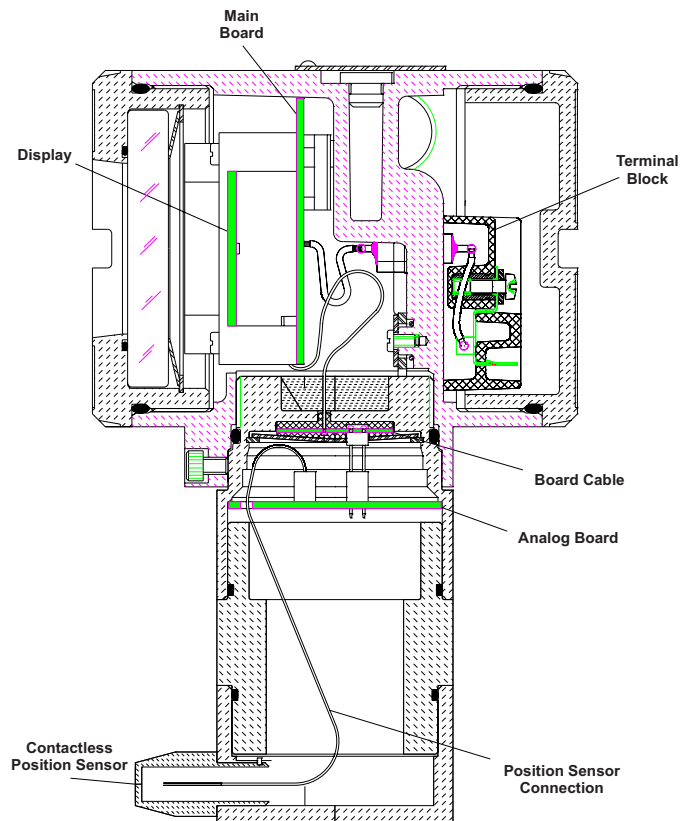

Local Adjustment

Through two switches activated by the magnetic tool without opening the equipment.

The **TP300** may be mounted on any linear or rotary valve, actuator or a variety of other equipment, such as skylights, dampers, rollers spacing, crushers, etc.

The Position Transmitter mounting depends on the type of movement it is applied, be it linear or rotary.

By using the mounting bracket supplied by Smar, it is easy to install the position transmitter in a wide variety of devices.

Mounting brackets for linear or rotary courses or remote sensor applications have an "L" shaped profile for fixing on a 2" pipe.

To measure linear movement beyond 100 mm linear stroke, use the **BFY-CL** (<http://www.smar.com>).



TP300 Packing

Transmitter Models

Linear

Local or remote configuration, from 3 mm to 100 mm of linear stroke.

To increase the measurement up to 1000 mm linear stroke, use the **BFY-CL** (<http://www.smar.com>).

Rotary

Local or remote configuration from 30° to 120°.

Contactless Local Position Sensor

Standard Position Sensor.

Contactless Remote Position Sensor

Best indicated for high temperature and vibration applications. Also adequate for difficult access locations. Available in 5 m to 20 m cable lengths.

Output

Reverse Output or Direct Action.



TP300 - Remote Sensor



TP300 - Integrated Sensor

Diagnostics and Parameterization

The **TP300** series is available in the **HART®**, **FOUNDATION™ fieldbus** and **PROFIBUS PA** Technologies. These devices can be configured with the Smar software configuration tools, and those from other manufacturers. Local adjustment is available on the **TP300** series. The magnetic tool is used to locally configure the control parameters and several functions.

Additionally, Smar developed the AssetView application, a web tool with friendly interface that may be accessed at any time and place with an Internet navigator.

HART® TP301

TP301 (HART® protocol) can be configured by:

- Smar CONF401 for Windows;
- Smar DDCON 100 for Windows;
- Smar HPC301 and HPC401 for several models of Palm™;
- Other manufacturers' configuration tools based on DD (Device Description) or FDT/DTM (Device Type Manager), such as AMS™, Simatic PDM, FieldCare™, PACTware™, HHT275 and HHT375, PRM Device Viewer.



FOUNDATION™ fieldbus TP302

The TP302 uses the H1 communication protocol, the open technology that makes possible for any enabled H1 tool to configure this equipment.

The System Configurator Tool is a software used to configure, operate and provide maintenance for the field equipment. The Syscon offers efficient and friendly interaction with the users that operate the Windows.

Configuration tools like AMS™, FieldCare™, HHT375 e HHT475 can configure the TP302. DD (Device Description) and CF (Capability File) files may be downloaded from the Smar site or Fieldbus FOUNDATION™ site.

The TP302 supports complex configuration strategies due to its high capacity and variety of the instantiable functional blocks.

Eleven functional block types are available. The fieldbus technology enables the AssetView application to access status and diagnostics information. Therefore, the maintenance procedures become more efficient, providing more safety and plant availability.

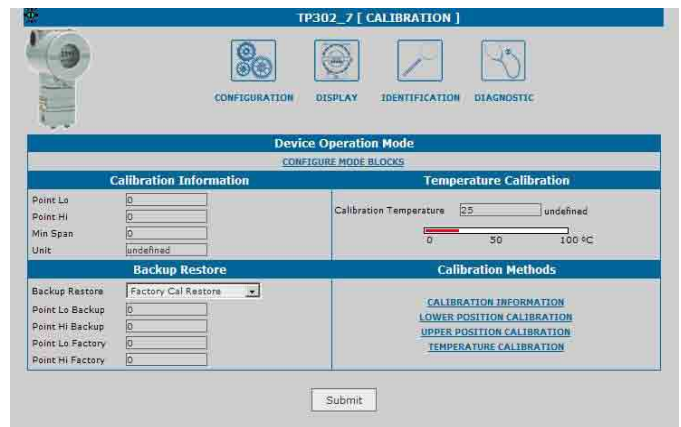

PROFIBUS PA TP303

These devices can be configured by the Smar ProfibusView or the Siemens Simatic PDM.

The TP303 was designed to use the PROFIBUS PA protocol and it is configured using the Simatic PDM or the FDT (Field Device Tool) and DTM (Device Type Manager) tools concept, such as FieldCare™ e PACTware™. It can also be configured by any PROFIBUS system that uses de GSD files.

The PROFIBUS PA also provides information on quality and diagnostics to improve the plant management and maintenance.

The EDDL (Electronica Device Description Language) and DTM files are available on the Smar site at the Internet.

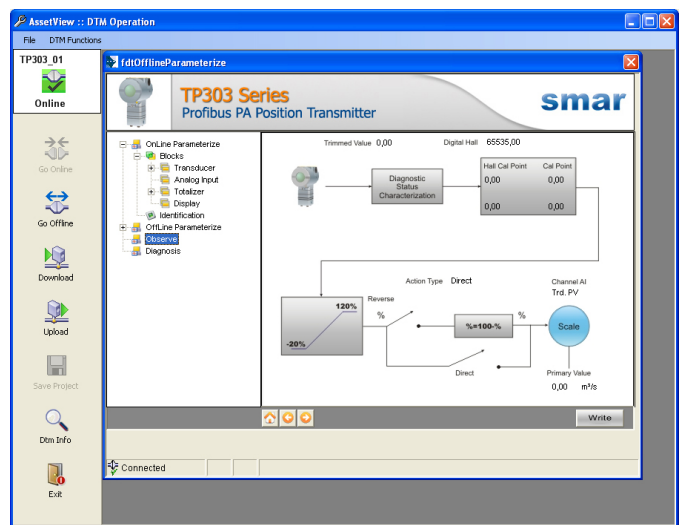

HART® - TP301

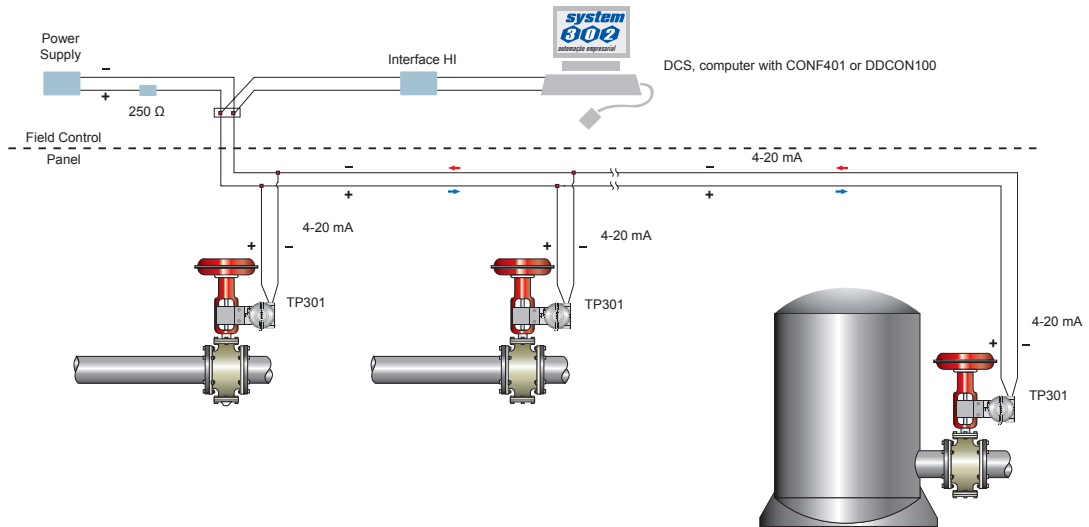

FOUNDATION™ fieldbus - TP302

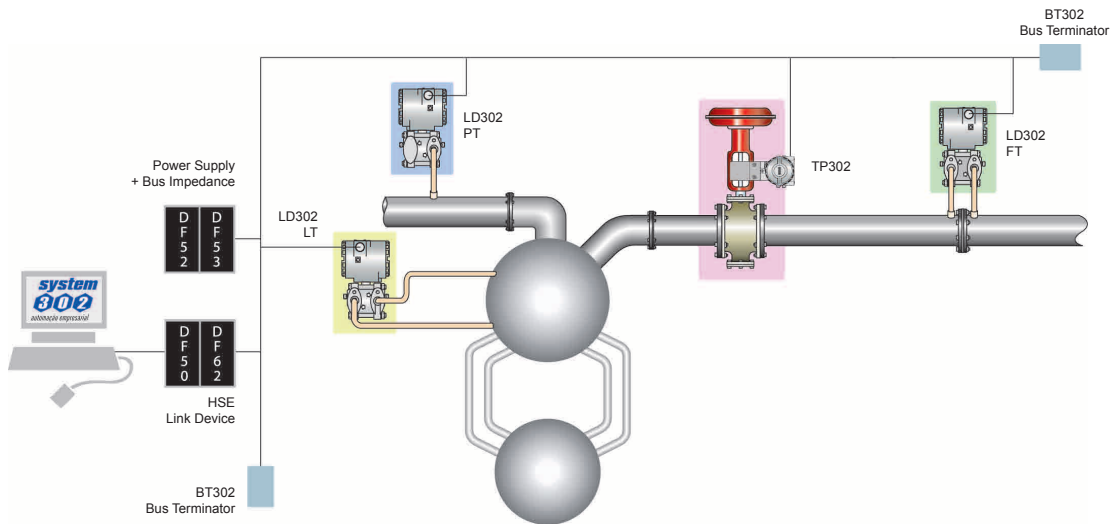

PROFIBUS PA - TP303

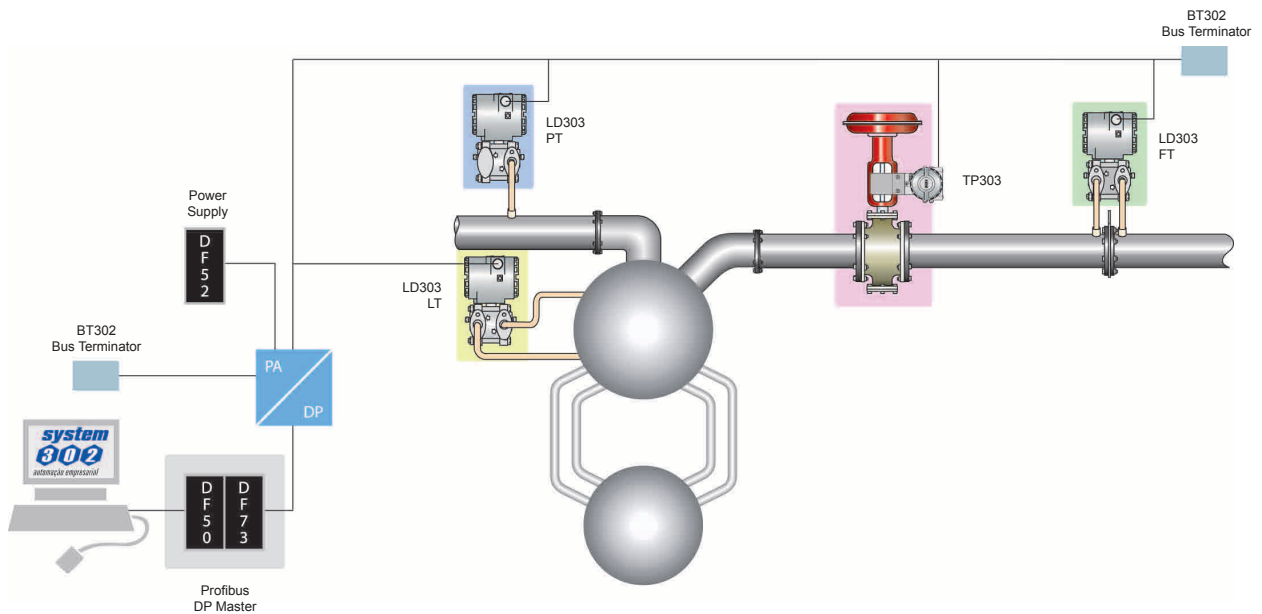

Functional Specifications

Travel	Linear Motion: 3 - 100 mm. (For measurement beyond 100 mm consult the BFY-CL catalog at www.smar.com). Rotary Motion: 30° - 120° Rotation Angle.
Output and Communication Protocol	HART® Two-wire 4-20 mA (TP290) with digital overlaid communication (HART® Protocol) compliant with NAMUR NE-43 (TP301). FOUNDATION™ fieldbus and PROFIBUS PA Only digital, compliant with IEC 61158-2 (H1) 31,25 Kbit/s with power supply through the bus.
Zero and Span Adjustment	Non-interactive adjustment, via digital communication or local adjustment.
Indicator	Rotary CLD with 4½ - numerical digits and 5 alphanumeric characters. Function and Status Indication (optional).
Hazardous Area Certifications	Explosion-proof and intrinsically safe (ATEX (NEMKO and DEKRA EXAM), FM, CEPEL and CSA). Designed to comply with European regulations ATEX 94/9/EC, LVD 2006/95/EC and EMC 2004/108/EC standards.
Temperature Limits	Ambient: -40 to 85 °C (-40 to 185 °F). Storage: -40 to 90 °C (-40 to 194 °F). Digital Display: -10 to 75 °C (14 to 167 °F) in operation; -40 to 85 °C (-40 to 185 °F) without damages. Remote Sensor: -40 to 105 °C (-40 to 221 °F).
Configuration	4 to 20 mA Local adjustment and configuration with the use of the magnetic tool and digital display. HART® By digital communication (HART® protocol) using the configuration software CONF401, DDCON (for windows), HPC301 or HPC401 (for Palm™). It can also be configured using DD and FDT/DTM tools, and can be partially configured through local adjustment. FOUNDATION™ fieldbus and PROFIBUS PA Basic configuration may be done using the local adjustment magnetic tool if device is fitted with display. Complete configuration is possible using configuration tools.
Humidity Limits	0 to 100% RH (Non-condensable Relative Humidity).
Failure Alarms	In case of sensor or circuit failures the self-diagnostics directs the output on 3.8 or 21.0 mA, at the user's choice.
Protection Against Reverse Polarity	12 to 45 Vdc.
Update Time	Around 150 ms.
Operation Start Time	The performance within specifications is smaller than 5 seconds after power supply is applied to the transmitter.
Output	Direct or reverse.
Position Sensor	Non-contact Hall effect sensor.

Performance Specifications

Accuracy	≤ 0.2% F. S. the effects of linearity, hysteresis and repeatability are included. (NOTE: Valid value only when used with the table of points. Refer to the Configuration Section on the Instructions Manual).
Resolution	≤ 0.1% F. S.
Repeatability	≤ 0.5% F. S.
Hysteresis of Full Scale	≤ 0.2% F. S.
Stability	± 0.1% F. S.
Temperature Effect	± 0.8% / 20°C F. S.
Power Supply Effect	± 0.005% F. S. Calibration.
Electromagnetic Interference Effect	Designed to comply with European Directive EMC 2004/108/EC.

Physical Specifications

Electrical Connection See Note (*)	½ - 14 NPT. M20 X 1.5. PG 13.5 DIN.	¾ - 14 NPT (with 316 SST adapter for ½ - 14 NPT). ¾ - 14 BSP (with 316 SST adapter for ½ - 14 NPT). ½ - 14 BSP (with 316 SST adapter for ½ - 14 NPT).
Material of Construction	Injected low copper aluminum with polyester painting or 316 Stainless Steel housing, with Buna N O-Rings on cover. Identification Plate: 316 SST.	
Mounting Brackets	Bichromatized Carbon Steel with polyester paint of Stainless Steel 316.	
Approximate Weight	<p>TP 1.5 kg in Aluminum (without mounting bracket); 3.3 kg in Stainless Steel (without mounting bracket).</p> <p>Remote sensor: 0.58 kg in Aluminum; 1.5 kg in Stainless Steel.</p> <p>Cable and remote sensor connectors: Cable 0.045 kg/m; 0.05 kg for each connector.</p>	

HART® is a trademark of HART® Communication Foundation.
FOUNDATION™ Fieldbus
PROFIBUS PA

(*) Consult Smar for applications in classified areas.

MODEL	POSITION TRANSMITTER		
TP290	4 to 20 mA		
TP301	HART® & 4 to 20 mA		
TP302	FOUNDATION™ fieldbus		
TP303	PROFIBUS PA		
COD.	Local Display		
0	Without Local Display		
1	With Local Display		
COD.	Mounting Bracket		
0	Without Bracket		
1	Carbon Steel, "L" + clamp "U" pipe 2". (3)		
2	Stainless Steel, "L" + clamp "U" pipe 2". (3)		
3	Carbon Steel, rotary - VDI / VDE NAMUR		
4	Stainless Steel, rotary - VDI / VDE NAMUR		
7	Carbon Steel, "L" + clamp "U" pipe 2" - (316 SST) accessories. (3)		
COD.	Electrical Connection		
0	1/2" - 14 NPT	3	1/2" - 14 NPT X 1/2 BSP (316 SST) - with adapter
1	1/2" - 14 NPT X 3/4 NPT (316 SST) - with adapter	A	M20 X 1.5
2	1/2" - 14 NPT X 3/4 BSP (316 SST) - with adapter	B	PG 13.5 DIN
COD.	Type of Actuator		
1	Rotary		
5	Linear Stroke up to 50 mm		
7	Linear Stroke up to 100 mm		
A	Linear Stroke up to 30 mm		
SPECIAL OPTIONS (1)			
CODE	Housing		
H0	Aluminum (IP/TYPE)	H2	Aluminum for saline atmosphere (IPW/TYPE X)
H1	316 Stainless Steel (IP/TYPE)	H3	316 Stainless Steel for saline atmosphere (IPW/TYPE X)
		H4	Copper Free Aluminium (IPW/TYPE X)
CODE	Identification Plate		
I1	FM: XP, IS, NI, DI	I5	CEPEL: EX-D, EX-IA, IP
I2	NEMKO: EX-D, EX-IA, IP (FOUNDATION™ fieldbus)	I6	Without certification
I3	CSA: XP, IS, NI, DI (FOUNDATION™ fieldbus and PROFIBUS PA)	IJ	NEMKO - EX-D
I4	EXAM (DMT): EX-IA, IP		
CODE	Painting		
P0	Gray Munsell N 6.5 Polyester		
P8	Without Painting		
P9	Blue Safety Epoxy – Electrostatic Painting		
PD	Blue smooth diamond RAL5010 - Epoxy		
CODE	TAG Plate		
J0	With TAG		
J1	Blank		
J2	According to user's notes		
CODE	Sensor Mounting (2)		
R0	Full Mounting		
R1	Remote sensor - 5 m cable		
R2	Remote sensor - 10 m cable		
R3	Remote sensor - 15 m cable		
R4	Remote sensor - 20 m cable		
CODE	Special		
ZZ	See notes		

TP290	-	1	0	-	0	1	*	•	*	/	*	/	*	/	*	/	*
TP301	-	1	0	-	0	1	*	•	*	/	*	/	*	/	*	/	*
TP302	-	1	0	-	0	1	*	•	*	/	*	/	*	/	*	/	*
TP303	-	1	0	-	0	1	*	•	*	/	*	/	*	/	*	/	*

← TYPICAL MODEL NUMBER

(1) Leave it blank when there are not optional items. TP290 standard model is supplied with local display.
 (2) Consult us for classified areas applications.
 (3) Magnet mounting bracket not supplied with the TP.

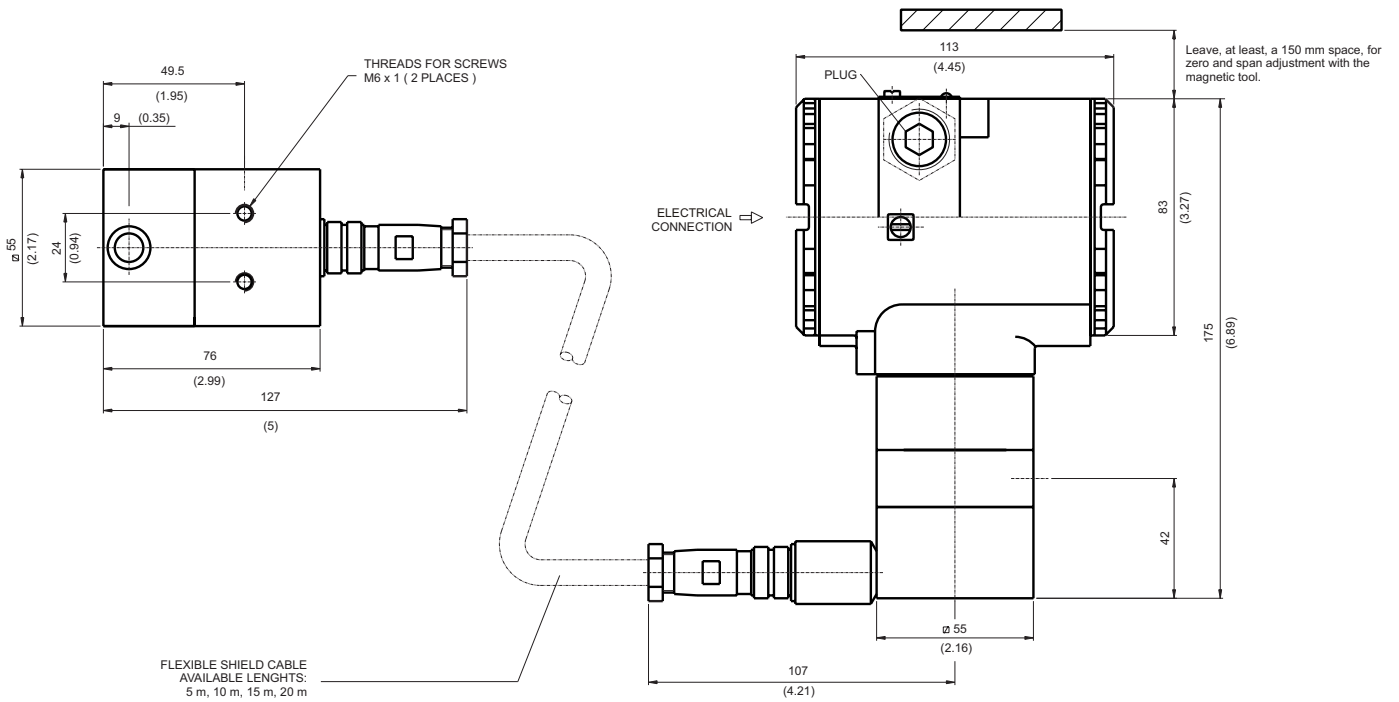
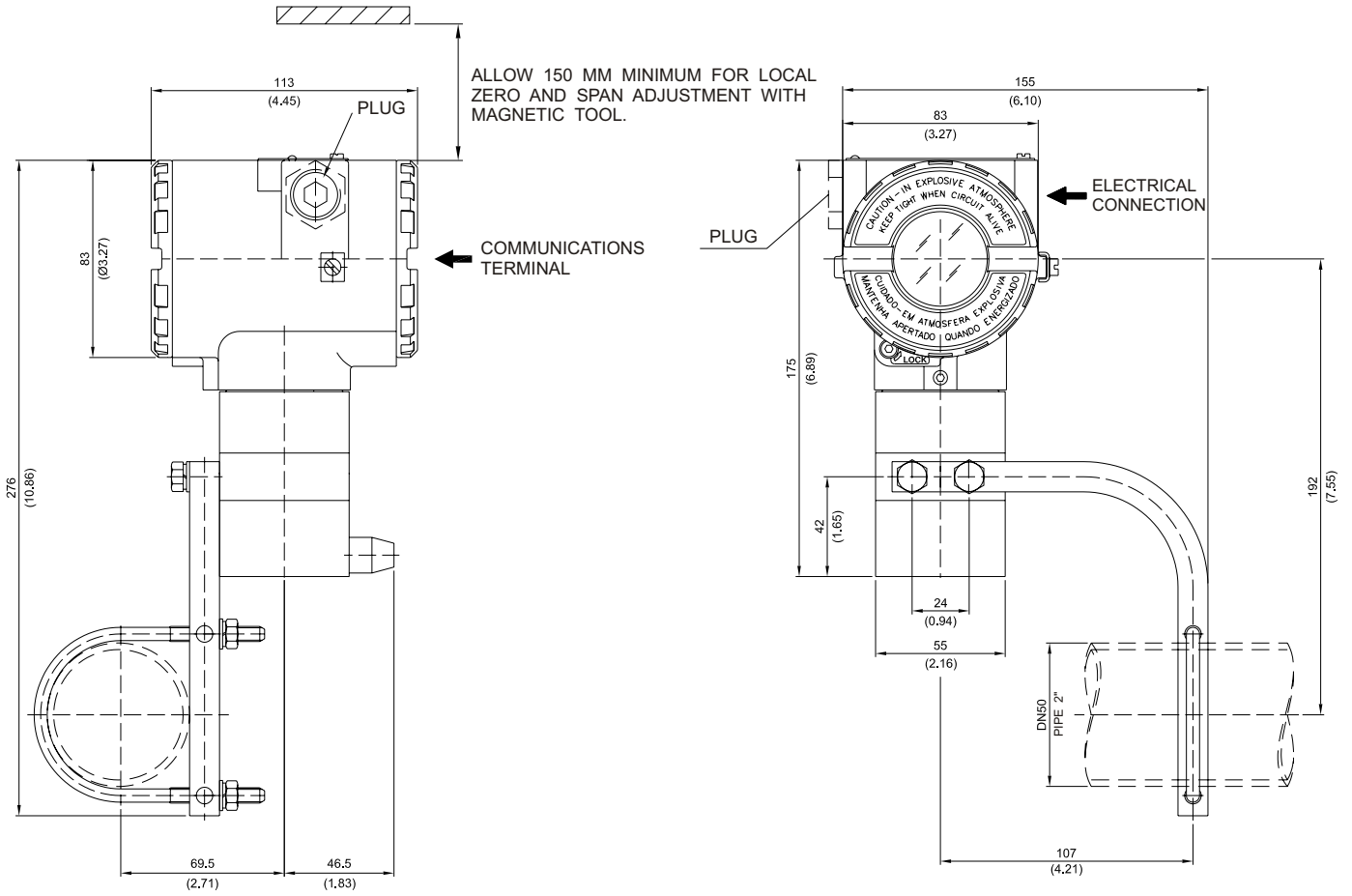



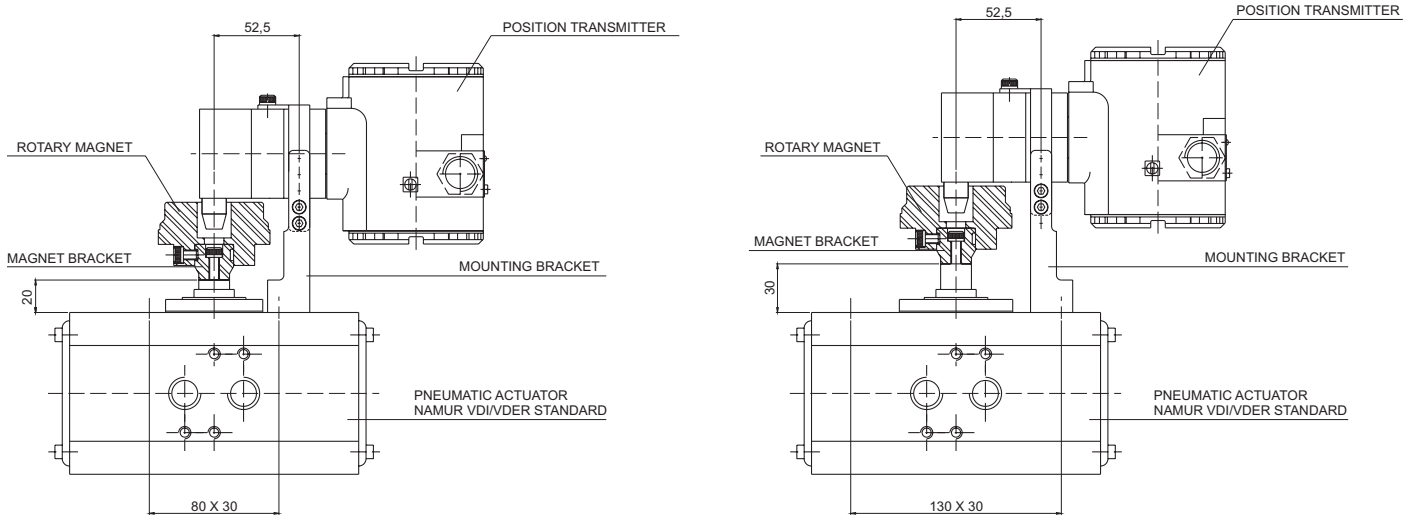

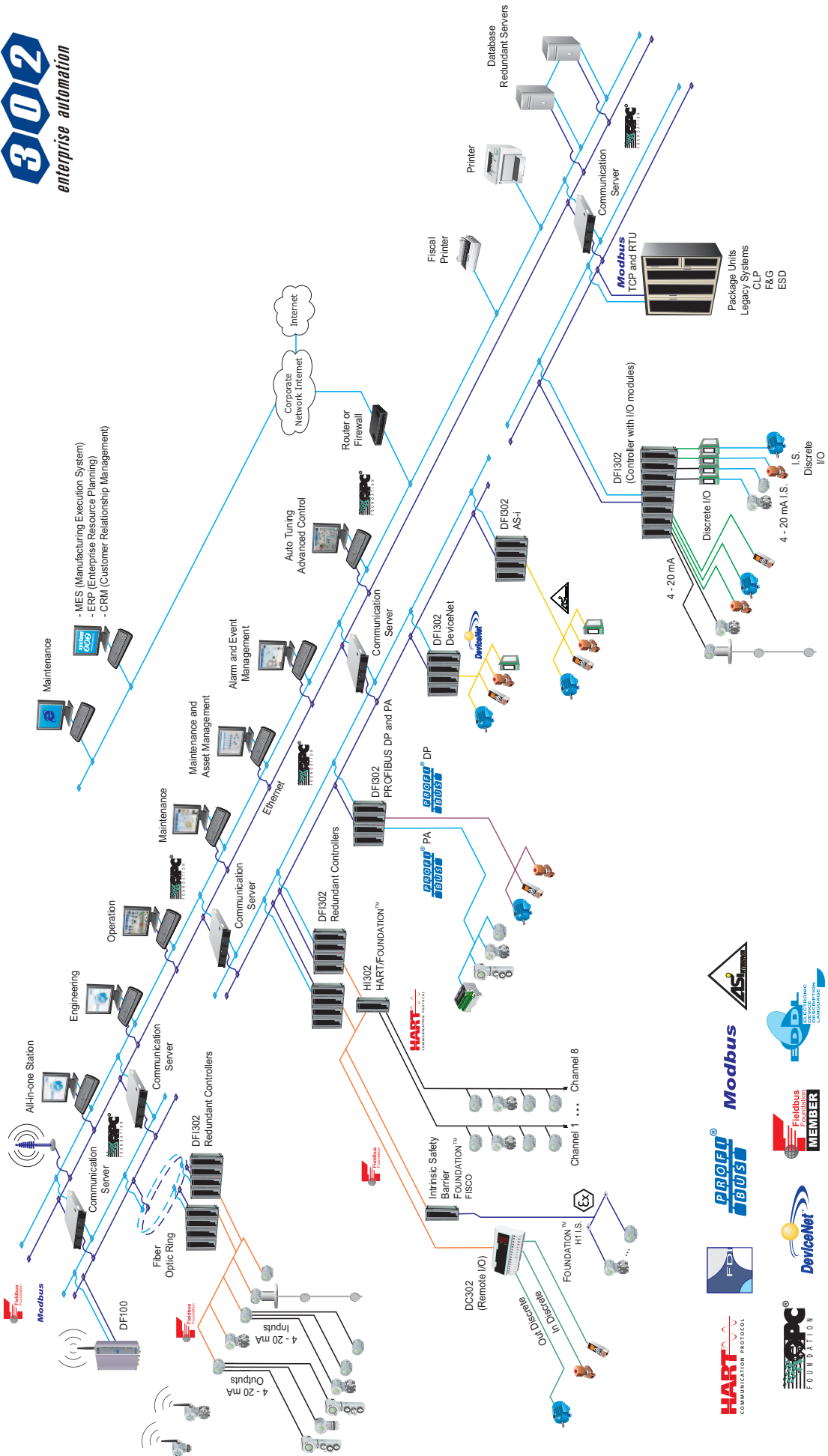









Special Mounting Bracket - Rotary VDI / VDE NAMUR























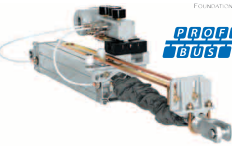
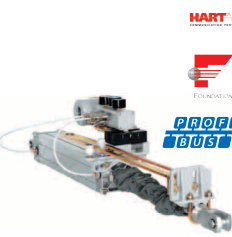
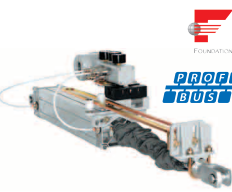
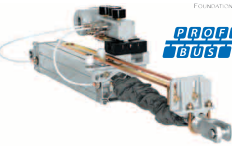

Pressure Pressure and Level Pressure, Level and Flow

<p>4-20 mA LD290  HART LD291  HART LD1.0  FOUNDATION LD292  FOUNDATION LD293</p>	<p>4-20 mA LD290  HART LD291  FOUNDATION LD292  FOUNDATION LD293</p>	<p>4-20 mA LD290  HART LD291  FOUNDATION LD292  FOUNDATION LD293</p>	<p>HART LD301  HART LD302  FOUNDATION LD303</p>	<p>HART LD400 </p>	<p>WirelessHART LD400 </p>	
<p>Pressure Transmitter "In Line"</p>	<p>Gauge Economic Capacitive Pressure Transmitter</p>	<p>Flanged Transmitter</p>	<p>Pressure Transmitter with Extended Probe</p>	<p>Pressure Transmitter</p>	<p>Pressure Transmitter with High Performance</p>	<p>WirelessHART Pressure Transmitter</p>

Level Density/Concentration Position

<p>RD400  HART  FOUNDATION</p>	<p>DT301  HART  FOUNDATION DT302  FOUNDATION DT303</p>	<p>FY301  HART  FOUNDATION FY302  FOUNDATION FY303</p>	<p>FY400  HART</p>
<p>Guided Wave Level Transmitter</p>	<p>Intelligent Density / Concentration Transmitter</p>	<p>Valve Positioner</p>	<p>Valve Positioner with Auto Tuning</p>

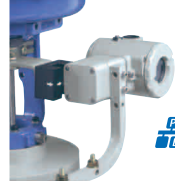
Position

<p>FY400  HART  FOUNDATION FY301  FOUNDATION FY302  FOUNDATION FY303</p>	<p>ACP400  HART  FOUNDATION ACP301  FOUNDATION ACP302  FOUNDATION ACP303</p>	<p>ACP400  HART  FOUNDATION ACP301  FOUNDATION ACP302  FOUNDATION ACP303</p>	<p>4-20 mA TP290  HART  FOUNDATION TP301  FOUNDATION TP302  FOUNDATION TP303</p>
<p>Valve Positioner with Remote Sensor</p>	<p>Pneumatic Linear Cylindric Actuator</p>	<p>Pneumatic Rotary Cylindric Actuator</p>	<p>Position Transmitter</p>

Temperature

<p>TT301  HART  FOUNDATION TT302  FOUNDATION TT303</p>	<p>TT383 </p>	<p>TT400 HART® SIS </p>	<p>WirelessHART TT400 </p>	<p>TT411 </p>	<p>TT421 </p>
<p>Temperature Transmitter</p>	<p>Eight Input Temperature Transmitter</p>	<p>Smart Temperature Transmitter</p>	<p>WirelessHART Temperature Transmitter</p>	<p>Panel Mounting Temperature Transmitter</p>	<p>Head Mounting Temperature Transmitter</p>

Junction Box

Didactic Products

JM1

JM400

PD3

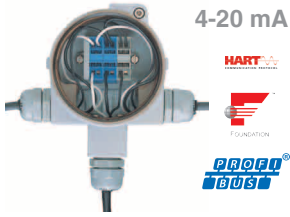

4-20 mA



3 Ways Junction Box



4-20 mA



4 Ways Junction Box



Didactic Plant



Didactical Kits

Configurators

Interfaces

HART[®] CONF401

HART[®] DDCON 100

HART[®] HI311/HI321

PBI-PLUS

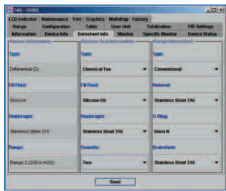

HART[®] Configurator Interface

HART[®] Configurator Interface

HART[®] Configurator

HART-USB Interface for PC

Advanced PROFIBUS PA Interface

Converters

HI302

HART[®] HCC301



FOUNDATION[™] / PROFIBUS PA to Pneumatic Signal Converter



Triple Channel Current to FOUNDATION[™] / PROFIBUS PA Converters



Triple Channel FOUNDATION[™] / PROFIBUS PA to Current Converters



FOUNDATION[™] / PROFIBUS PA Relay and Digital Input



HART[®] / Fieldbus Interface



HART[®] / Current Converter

Controllers

DFI302

LC700

CD600Plus



Interface Universal Fieldbus



Programmable Logical Controller



Digital Controller

Controllers - Remote Input and Output

WirelessHART DF100



HSE Controller and WirelessHART Gateway

DC303



FOUNDATION™ fieldbus / PROFIBUS PA Remote Input and Output

DC302



SYSTEM302



ProcessView Supervision / Operation System



SimulationView Control Strategy Simulator

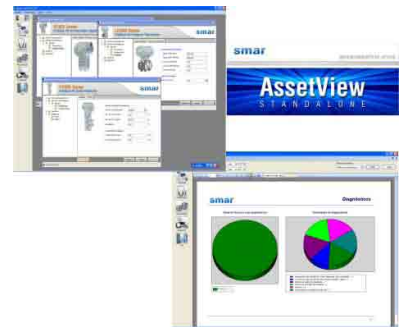

AssetView STANDALONE Asset Management System

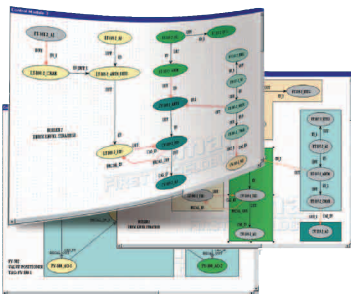

Syscon Control Strategy and Industrial Network Configurator

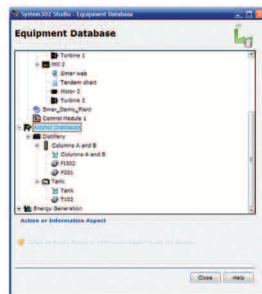

Process Equipment Database Plant Information Management

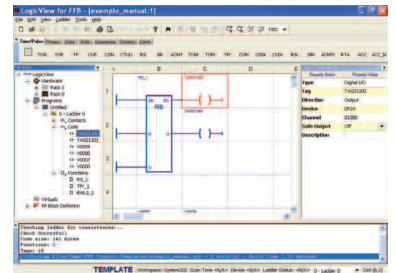

LogicView for FFB IEC61131 Programming Tool



smar
www.smar.com

Specifications and information are subject to change without notice.
Up-to-date address information is available on our website.

web: www.smar.com/contactus.asp



TP300CE